



Thermistor overload relay for machine protection, 1W , 24-240V50/60Hz, 24-240VDC, without reclosing lockout

Part no. EMT6
Catalog No. 066166
Alternate Catalog No. EMT6
EL-Nummer (Norway) 4110419

Delivery program

Product range				EMT6 thermistor overload relay for machine protection
Function				Without manual reset Mains and fault LED display Test button
Rated operational current				
AC-15				
240 V	I_e	A		3
AC--14				
300 V	I_e	A		3
400 V	I_e	A		3
				Value applies starting with release 001.
conventional thermal current	I_{th}	A		6
Rated control voltage	U_s	V		24 - 240 V 50 - 400 Hz 24 - 240 V DC
Notes				
Observe manual MN03407006Z-DE/EN.				
Can be snap fitted on a top-hat rail to IEC/EN 60715.				

Technical data

General				
Standards				IEC/EN 60947, VDE 0660, EN 55011
Climatic proofing				Damp heat, constant, to IEC 60068-2-78; Damp heat, cyclic, to IEC 60068-2-30
Ambient temperature				
Open		°C		-25 - +60
Enclosed		°C		- 25 - 45
Storage		°C		- 45 - 85
Mounting position				As required
Weight		kg		0.15
Mechanical shock resistance half-sinusoidal shock 10 ms to IEC 60068-2-27		g		10
Degree of Protection				IP20
Protection against direct contact when actuated from front (EN 50274)				Finger and back-of-hand proof
Safe isolation to EN 61140				
between the contacts		V AC		250
between contacts and power supply		V AC		250

Auxiliary and control circuits

Rated impulse withstand voltage	U_{imp}	V AC		4000
Rated impulse withstand voltage	U_{imp}	V AC		6000
				Value applies starting with release 001.
Overvoltage category/pollution degree				III/3
Terminal capacities Auxiliary and control circuits				
Solid		mm ²		1 x (0.5 - 2.5) 2 x (0.5 - 1.5)
Flexible with ferrule		mm ²		1 x (0.5 - 2.5) 2 x (0.5 - 1.5)
Solid or stranded		AWG		20 - 14
Terminal screw				M3.5

Tightening torque		Nm	1.2
Tools			
Pozidriv screwdriver		Size	2
Standard screwdriver		mm	1 x 6

Auxiliary power circuit

Rated insulation voltage	U_i	V	300
Rated insulation voltage	U_i	V	400
			Value applies starting with release 001.
Rated operational current	I_e	A	
AC--14			
Make contact			
300 V	I_e	A	3
380 V 400 V 415 V	I_e	A	3
			Value applies starting with release 001.
Break contact			
300 V	I_e	A	3
380 V 400 V 415 V	I_e	A	3
			Value applies starting with release 001.
AC-15			
Make contact			
220 V 230 V 240 V	I_e	A	3
300 V	I_e	A	1
380 V 400 V 415 V	I_e	A	1
			Value applies starting with release 001.
Break contact			
220 V 230 V 240 V	I_e	A	3
300 V	I_e	A	1
380 V 400 V 415 V	I_e	A	1
			Value applies starting with release 001.
Max. short-circuit protective device			
Fuse	gG/gL	A	6

Control circuit

Rated insulation voltage	U_i	V	240
Rated operational voltage	U_e	V	240
Pick-up and drop-out values		x U_e	0.85 - 1.1
Power consumption			
AC		VA	3.5
DC		W	2
Trip at approx.		Ω	3600
Recovery at approx.		Ω	1600
Sensor circuit			Sensor circuit parameters at U_S and +20 °C: max. Cable length to sensor 250m (not insulated) Total cold resistance $\sum R_K \leq 1500 \Omega$ - R_{T1-T2} (T1, T2 shorted): $I_{T1-T2} = 1.9 \text{ mA}$ - R_{T1-T2} (4 k Ω): $U_{T1-T2} = \text{max. } 3 \text{ V DC}$, $I_{T1-T2} = \text{max. } 0.8 \text{ mA}$ - R_{T1-T2} (T1, T2 open): $U_{T1-T2} = 5.1 \text{ V DC typ. (5.5 V DC max.)}$

Electromagnetic compatibility (EMC)

Electrostatic discharge (ESD)			
applied standard			IEC/EN 61000-4-2
Air discharge		kV	8
Contact discharge		kV	6
Electromagnetic fields (RFI)			
applied standard			IEC/EN 61000-4-3
		V/m	80 - 1000 MHz: 10 1.4 - 2 GHz: 3 2.0 - 2.7 GHz: 1
Radio interference suppression			EN 55011 Class B

Burst		kV	Supply cables: 2 Signal cables: 1 according to IEC/EN 61000-4-4
power pulses (Surge)			2 kV (symmetrical) 4 kV (asymmetrical) according to IEC/EN 61000-4-5
Immunity to line-conducted interference to (IEC/EN 61000-4-6)		V	10

Design verification as per IEC/EN 61439

Technical data for design verification			
Rated operational current for specified heat dissipation	I_n	A	0
Heat dissipation per pole, current-dependent	P_{vid}	W	0
Equipment heat dissipation, current-dependent	P_{vid}	W	0
Static heat dissipation, non-current-dependent	P_{vs}	W	0.8
Heat dissipation capacity	P_{diss}	W	0
Operating ambient temperature min.		°C	-25
Operating ambient temperature max.		°C	60

Technical data ETIM 8.0

Relays (EG000019) / Temperature monitoring relay (EC001446)			
Electric engineering, automation, process control engineering / Low-voltage switch technology / Monitoring equipment (low-voltage switch technology) / Temperature monitoring equipment (ecl@ss10.0.1-27-37-18-10 [AKF104014])			
Type of electric connection			Screw connection
Rated control supply voltage U_s at AC 50HZ		V	24 - 240
Rated control supply voltage U_s at AC 60HZ		V	24 - 240
Rated control supply voltage U_s at DC		V	24 - 240
Voltage type for actuating			AC/DC
With detachable clamps			No
Number of measuring circuits			1
Error registration possible			No
External reset possible			No
Number of contacts as normally closed contact			1
Number of contacts as normally open contact			1
Number of contacts as change-over contact			0
Temperature measuring range		°C	0 - 0
Resistance measuring range		Ohm	750 - 12000
Width		mm	23
Height		mm	83
Depth		mm	103

Approvals

Product Standards			UL 508; CSA-C22.2 No. 14; IEC/EN 60947-8; CE marking
UL File No.			E29184
UL Category Control No.			NKCR
CSA File No.			12528
CSA Class No.			3211-03
North America Certification			UL listed, CSA certified
Specially designed for North America			No
Max. Voltage Rating			600 V AC
Degree of Protection			IEC: IP20, UL/CSA Type: -

Characteristics

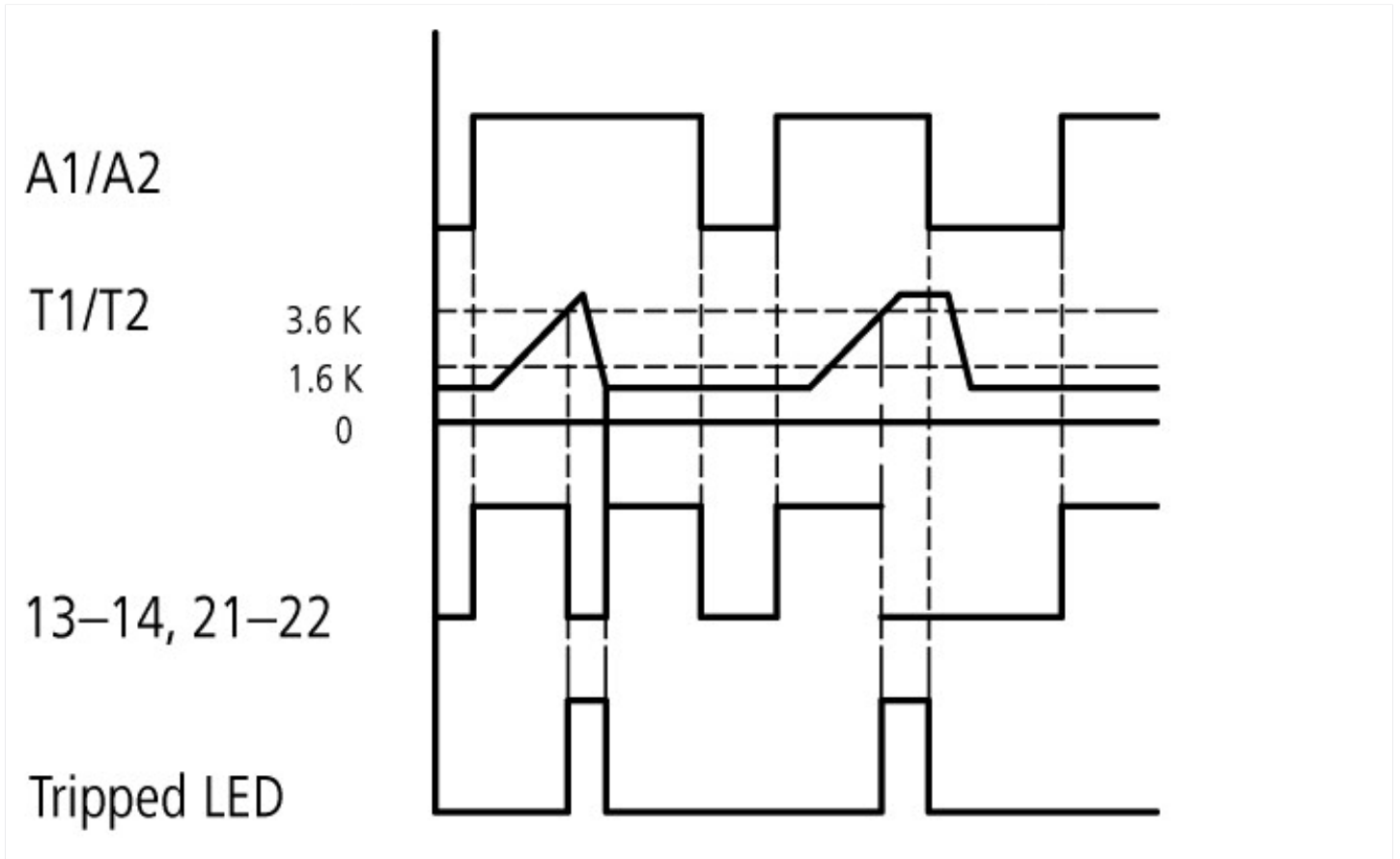

Dimensions

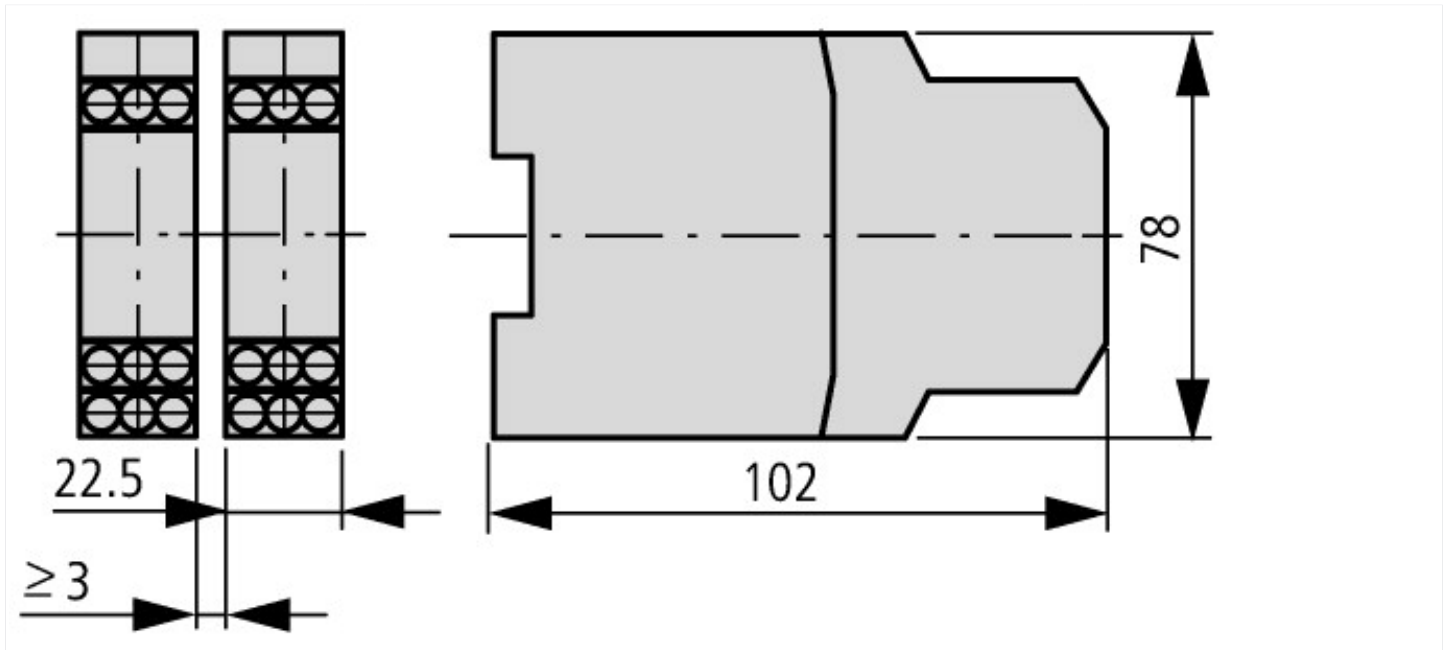

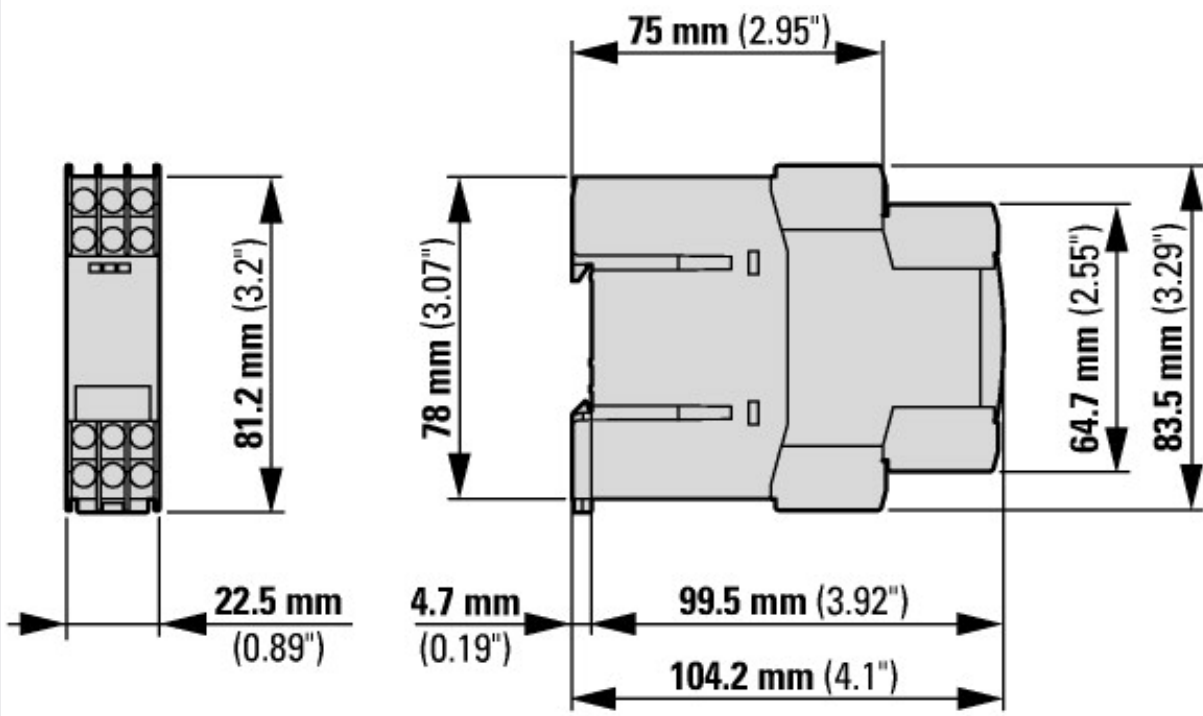

Applies to release 001 and higher

Additional product information (links)

terminal markings and sensor circuit

<http://de.ecat.moeller.net/flip-cat?edition=HPLTEv1&startpage=6.21>