

DALI RM8/16

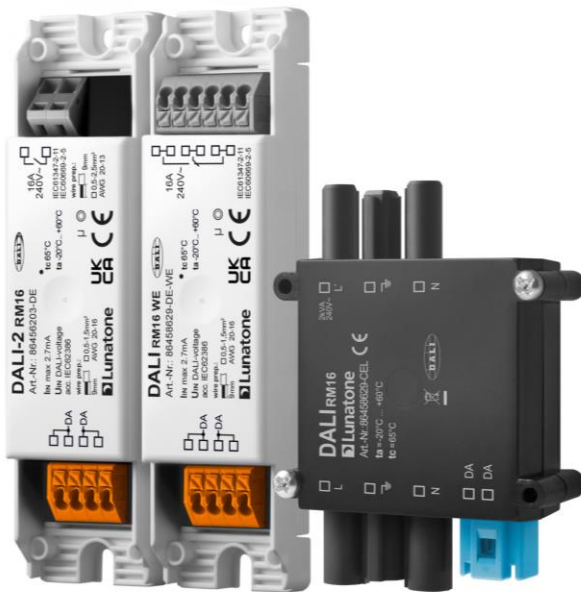



Datasheet DT7 Relay Module



Relay Module for the integration of non-dimmable ballasts in DALI lighting systems (DT7)





Rail mounting

	RM8 HS	Art.Nr. 86456944-HS
	RM8 HS	Art.Nr. 86458675-HS
	RM16 HS	Art.Nr. 86456203-HS
	RM16 HS	Art.Nr. 86458629-HS
	RM8 HS WE	Art.Nr. 86456944-HS-WE
	RM16 HS WE	Art.Nr. 86456203-HS-WE
	RM16 HS WE	Art.Nr. 86458629-HS-WE

Remote ceiling

	RM16 DE	Art.Nr. 86456203-DE
	RM16 DE	Art.Nr. 86458629-DE
	RM16 DE WE	Art.Nr. 86458629-DE-WE
	RM16 CEL	Art.Nr. 86458629-CEL

Back box

	RM8	Art.Nr. 86456944
	RM8	Art. Nr. 86458675
	RM16	Art. Nr. 86456203
	RM16	Art. Nr. 86458629

DALI RM 8/16 DT7 Relay Module

Overview

- Compact relay module for the direct control of 230V AC loads via DALI
- DALI-2 certified variants available: art. nr.: 86456944- and art. nr.: 86456203-
- Ballasts without DALI-input can be simply integrated in a DALI lighting control system. The loads can then be switched ON and OFF by DALI commands.
- The DALI RM8/16 module fulfills the requirements for DALI Device Type 7 - switching function (firmware 2.0 and higher)
- Configurable Power-Up and System-Failure behaviour
- Free DALI-Cockpit software package for configuration of DALI-systems and Lunatone DALI components
- The RM 8/16 is supplied directly by the DALI signal line
- Zero cross switching
- RM16-HS (art. nr.: 86458629-HS, 86456203-HS) and RM16-DE (art. nr.: 86458629-DE, 86456203-DE): integrated current limiter, suitable for loads with high inrush current (>100A)
- The DALI RM 8/16 module acts like any conventional DALI ballast, and can be addressed and configured accordingly.

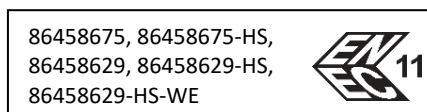
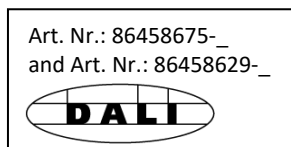

Specification, Characteristics

DIN Rail models

type	DALI RM8 HS	DALI RM16 HS	DALI-2 RM8 HS WE	DALI RM16 HS WE
article number	DALI: 86458675-HS DALI-2: 86456944-HS	DALI: 86458629-HS DALI-2: 86456203-HS	DALI-2: 86456944-HS-WE	DALI: 86458629-HS-WE DALI-2: 86456203-HS-WE
electrical data:				
supply	via DALI-line			
typ. current consumption	2.7 mA			
relay output switch on/off voltage	250Vac			

Type	DALI RM8 HS	DALI RM16 HS	DALI-2 RM8 HS WE	DALI RM16 HS WE
article number	DALI: 86458675-HS DALI-2: 86456944-HS	DALI: 86458629-HS DALI-2: 86456203-HS	DALI-2: 86456944-HS-WE	DALI: 86458629-HS-WE DALI-2: 86456203-HS-WE
max. nominal load circuit breaker	1000VA 6A max	2000VA 12A max	1000VA 6A max	2000VA 12A max
max. breaking current	8A	16A	8A	16A
max. inrush current	40A	limited to 100A	40A	80A
max. continuous current	8A	8A	8A	8A
switching method	zero cross switching	zero cross switching integrated current limiter	zero cross switching	zero cross switching
type of relay contact	1 normally open	1 normally open	1 changeover	1 changeover
switching operations at nominal load, resistive	>10 ⁵	>10 ⁵	>10 ⁵	>3x10 ⁴
maximum switching frequency	1Hz			
Input	DALI			
number of used DALI addresses	1			

technical data:

behaviour at Power Up	programmable: ON/OFF/no Change
behaviour at System failure	programmable: ON/OFF/no Change
storage and transportation temperature	-20°C ... 75°C
operating ambient temperature	-20°C ... 60°C
protection class	II in intended use
protection degree housing	IP40
protection degree terminals	IP20
connecting wire cross section	2.5 mm ²
dimensions	98mm x 17.5mm x 56mm

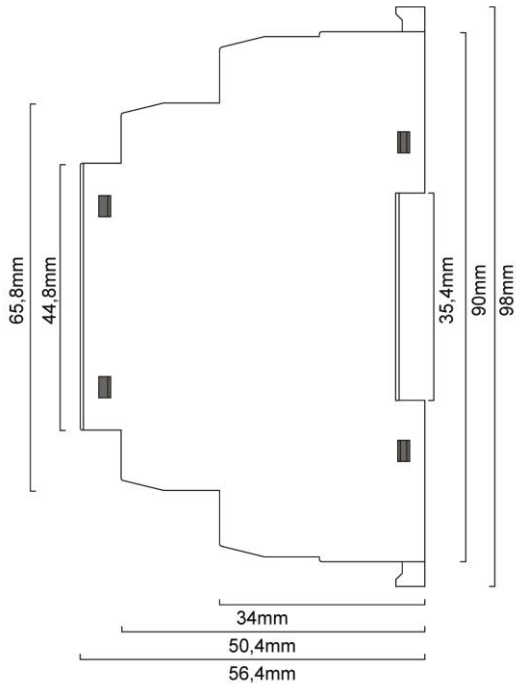

Geometry RM8 HS

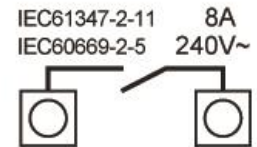

connection plan RM8 HS

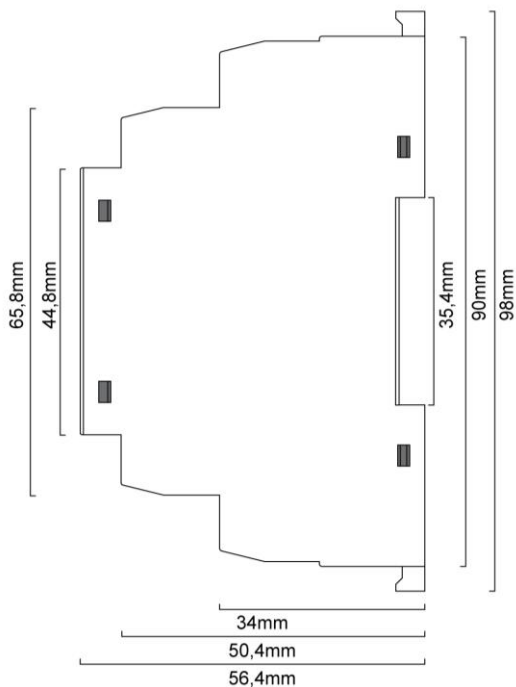

Geometry RM16 HS

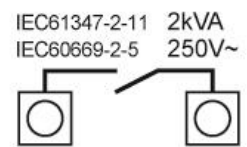

connection plan RM16 HS

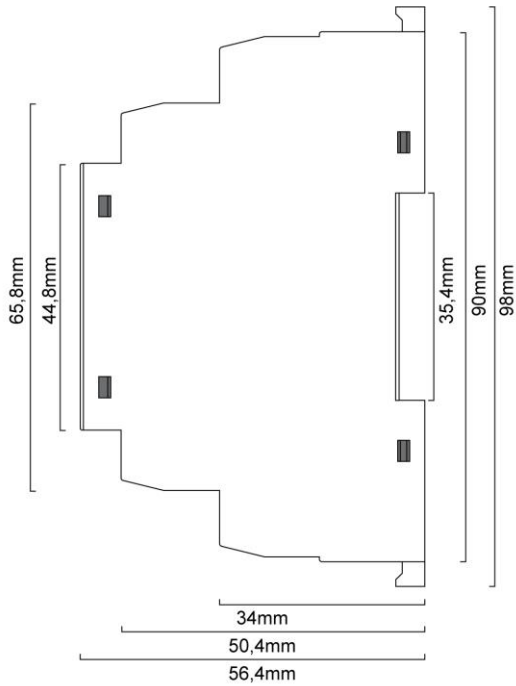

Geometry RM8 HS WE



17,5mm

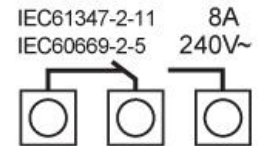

connection plan RM8 HS WE

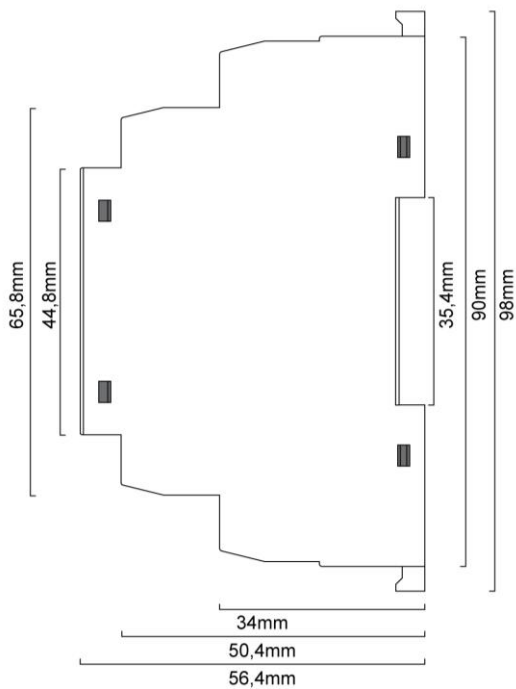

Geometry RM16 HS WE



17,5mm

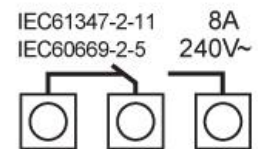

connection plan RM16 HS WE

Remote ceiling models

type	DALI RM16 DE	DALI RM16 DE-WE	DALI RM16 CEL
article number	DALI: 86458629-DE DALI-2: 86456203-DE	DALI: 86458629-DE-WE	DALI: 86458629-CEL

electrical data:

supply	via DALI-line		
typ. current consumption	2.7 mA		
relay output switch on/off voltage	250Vac		
max. nominal load	2000VA		
circuit breaker	12A max		
max. breaking current	25A	25A	25A
max. inrush current	internally limited to 100A	60A	80A
max. continuous current	16A	16A	16A
switching method	zero cross switching integrated current limiter	zero cross switching	zero cross switching
type of relay contact	1 normally open	1 changeover	1 normally open
switching operations at nominal load, resistive	>5x10 ⁴	>5x10 ⁴	>3x10 ⁴
maximum switching frequency	1Hz		
Input	DALI		
number of used DALI addresses	1		

technical data:

behaviour at Power Up	programmable: ON/OFF/no Change		
behaviour at System failure	programmable: ON/OFF/no Change		
storage and transportation temperature	-20°C ... 75°C		
operating ambient temperature	-20°C ... 60°C		
protection class	II in intended use		
protection degree housing	IP40		
protection degree terminals	IP20		
connecting wire cross section	relay output: 2.5 mm ² DALI: 1.5 mm ²	2x1.5 mm ²	-
dimensions	120mm x 30mm x 22mm		85mm x 62mm x 18mm

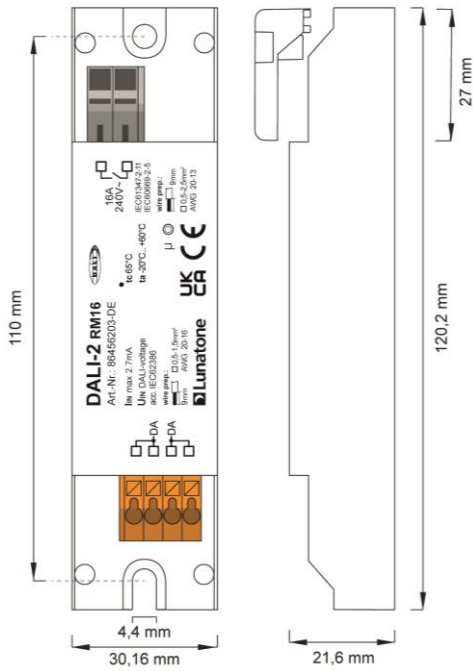

geometry RM16 DE



connection plan
RM16 DE

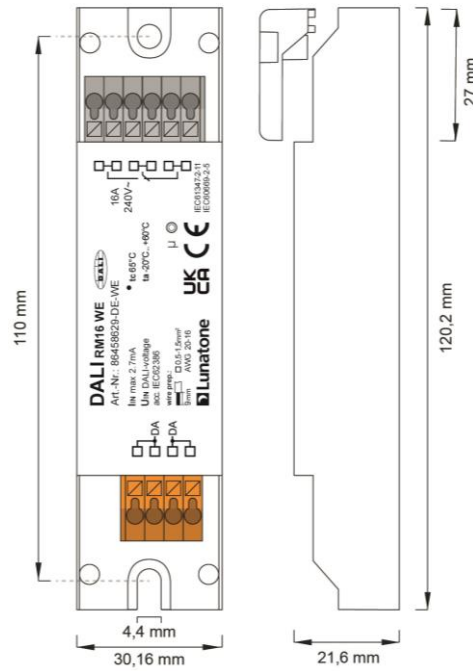

geometry RM16 DE WE



connection plan
RM16 DE WE

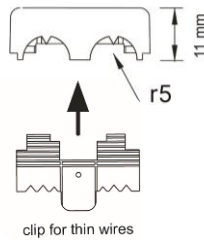
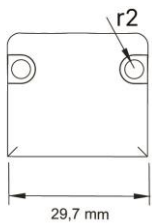

clip for thin wires

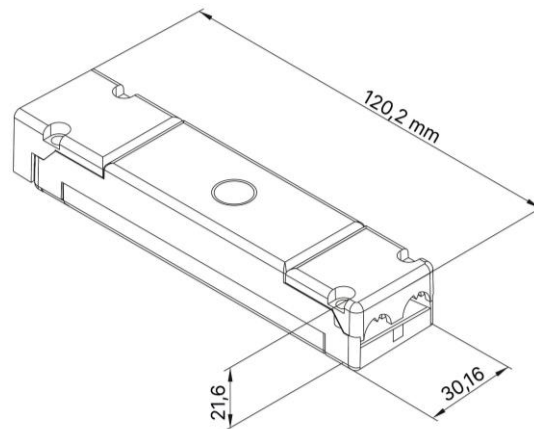

type with Wieland-connectors:

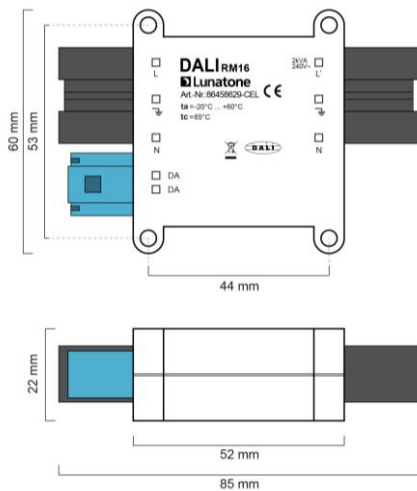

geometry RM16-CEL

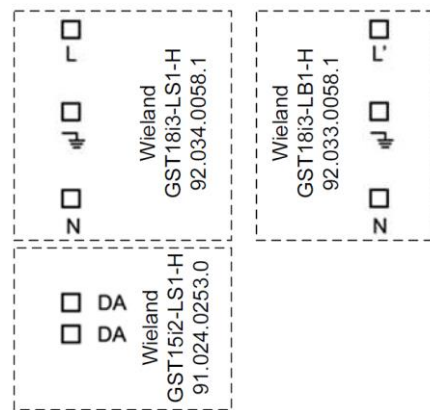

connection plan RM16-CEL

Installation box models

type	DALI RM16		DALI RM8	
article number	DALI:	86458629	DALI:	86458675
	DALI-2:	86456203	DALI-2:	86456944

electrical data:		
supply	via DALI-line	
typ. current consumption	2.7 mA	
relay output switch on/off voltage	250Vac	
max. nominal load	1000VA	1000VA
circuit breaker	6A max	6A max
max. breaking current	12A	12A
max. inrush current	60A	60A
max. continuous current	8A	8A
switching method	zero cross switching	
type of relay contact	1 changeover	1 normally open
switching operations at nominal load, resistive	>10 ⁵	>10 ⁵
maximum switching frequency	1Hz	
input	DALI	
number of used DALI addresses	1	

technical data:	
behaviour at Power Up	programmable: ON/OFF/no Change
behaviour at System failure	programmable: ON/OFF/no Change
storage and transportation temperature	-20°C ... 75°C
operating ambient temperature	-20°C ... 60°C
protection class	II in intended use
protection degree housing	IP40
protection degree terminals	IP20
connecting wire cross section	1.5 mm ²
dimensions	59mm x 33mm x 15mm

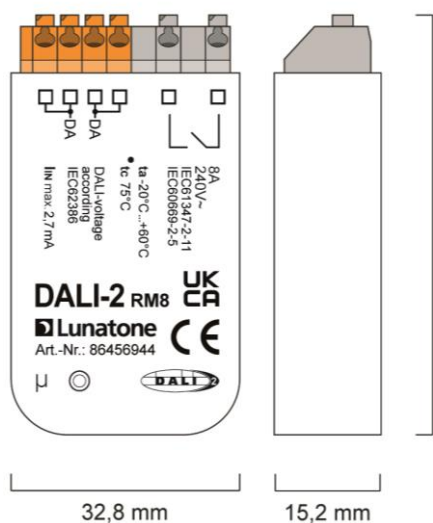

geometry RM8/RM16

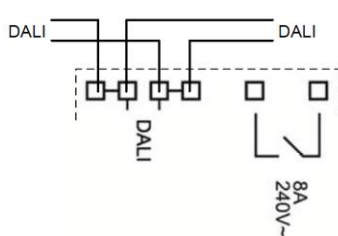

connection plan RM8

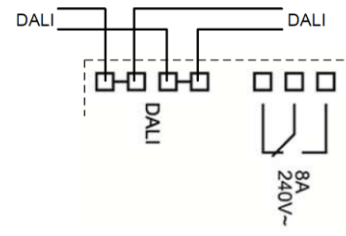

connection plan RM16

Typical Application

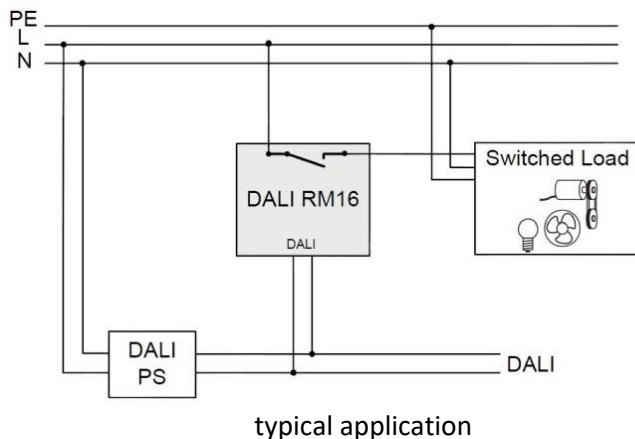

Hint: In order to ensure that the load current does not exceed the maximum switching current, the installation must be secured with a suitable automatic circuit breaker.

Installation

The relay module is supplied directly by the DALI-line. It must NOT be connected to the mains. A typical value of current consumption is 2.7mA. In order to supply components on a DALI line the installation of a DALI power supply (DALI PS) is necessary. The connection to the DALI line is polarity free. The DALI input is protected against overvoltage up to 250VAC. For RM8/16 and RM16-DE types internally the DALI-terminals are connected through as visualized on the housing (see connection plan).

The relay output of the RM8/16 supports loads up to 2000VA and switching currents up to 16A (type dependent, check specification for details). In order to ensure that the load current does not exceed the maximum switching current of the relay a suitable automatic circuit breaker has to be installed. Switching is done at zero cross of ac voltage, type RM16 DE (Art.Nr.: 86458629-DE) and RM16 HS (Art.Nr.: 86458629-HS) are also equipped with integrated current limiter and are therefore dedicated for loads with high inrush current >100A.

DALI-2 Version

The DALI-2 relay modules (art.nr.: 86456944-__ and art.nr.: 86456203-__) are the same as the previous DALI variants in terms of connection, functionality, they only differ in the DALI-2 certification. Due to the DALI-2 certification the "Identify" function was added (see section "Addressing and configuration").

DALI Functions and Instruction Set

The DALI RM 8/16 acts as a DALI-controlled relay contact. Hence ballasts can be integrated in a DALI-system and switched on and off by DALI commands.

The DALI RM8/16 acts like a standard DALI ballast for non-dimmable loads. It is based on the DALI specification for control gear (IEC 62386-102) and the device type 7 extension (IEC 62386-208). Therefore the switching characteristic is determined by the comparison of the virtual direct arc power level (VDAP) with 4 thresholds.

The virtual dim level (VDAP) is like the dim level of DALI-ballasts and is therefore limited by MINLEVEL and MAXLEVEL and influenced by fade-time and fade-rate.

For each dim direction 2 thresholds can be defined. They are compared with the virtual dim level and as a result the output is switched on or off:

virtual dim direction	comparison of virtual dim level and thresholds	output
UP	$VDAP \geq$ UP SwitchOn Threshold	ON
UP	$VDAP \geq$ UP SwitchOff Threshold	OFF
DOWN	$VDAP \leq$ DOWN SwitchOn Threshold	ON
DOWN	$VDAP \leq$ DOWN SwitchOff Threshold	OFF

If a threshold value is set to "MASK" the threshold is inactive and does not influence the relay output.

Some examples of switching characteristics below:

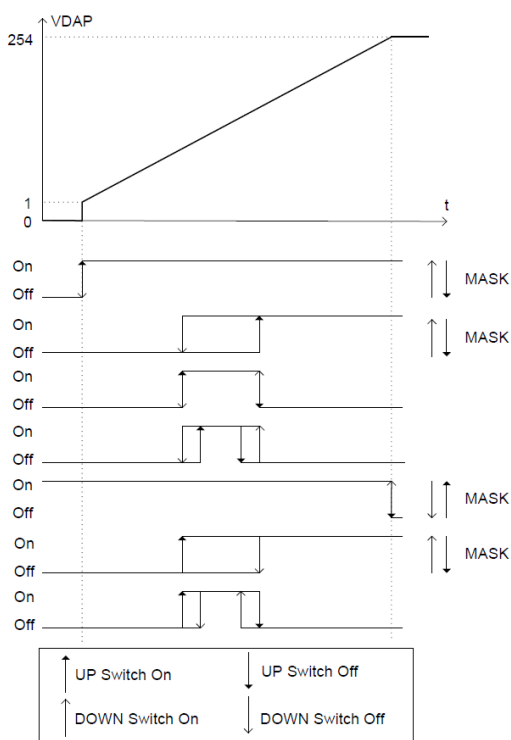

With the help of the fade time switch on and switch off delays can be realized.

The DALI RM8/16 is bus-powered. The reaction on a system failure can be configured (keep relay state, on or off, factory default: keep state (MASK)). In case of switching on

the DALI-line supply voltage the Power On level is applied.

Addressing and Configuration

The DALI RM 8/16 can be addressed (random addressing) and configured with the help of the DALI-Cockpit, a software tool, that can be downloaded from the Lunatone website.

When using the [DALI Cockpit Software](#), the PC must be connected to the DALI bus via a suitable interface module ([DALI-2 USB](#); [DALI USB](#), [DALI-2 WLAN](#), [DALI-2 Display](#), [DALI-2 IoT](#), [DALI 4Net](#), [DALI SCI RS232](#)). The DALI RM is automatically recognised by the DALI Cockpit during the addressing process and listed in the device overview.

The standard DALI device settings as well as the device specific settings can be configured in the DALI Cockpit

The DALI-2 Versions (art.nr.: 86456944-_ and art.nr.: 86456203-_) offers the "Identify" function for localization after addressing. With the DALI command IDENTIFY, or selecting the checkbox "localise" in the DALI Cockpit the relay switches.

lokalise

It must be ensured that the IDENTIFY command is not used if switching of the relay is not desired.

Purchase Information



DIN rail:

Art.Nr. 86458675-HS: DALI RM8 HS, 1000VA/8A, zero cross switching, 1 normal open, DIN rail mounting

Art.Nr. 86456944-HS: DALI-2 RM8 HS, 1000VA/8A, zero cross switching, 1 normal open, DALI-2 certified, DIN rail mounting

Art.Nr. 86458629-HS: DALI RM16 HS, 2000VA/16A, zero cross switching, integrated current limiter, 1 normal open, DIN rail mounting

Art.Nr. 86456203-HS: DALI-2 RM16 HS, 2000VA/16A, zero cross switching, integrated current limiter, 1 normal open, DALI-2 certified, DIN rail mounting

Art.Nr. 86456944-HS-WE: DALI-2 RM8 HS WE, 1000VA/8A, zero cross switching, 1 changeover, DALI-2 certified, DIN rail mounting

Art.Nr. 86458629-HS-WE: DALI RM16 HS WE, 2000VA/16A, zero cross switching, 1 changeover, DIN rail mounting

Art.Nr. 86456203-HS-WE: DALI-2 RM16 HS WE, 2000VA/8A, zero cross switching, 1 changeover, DALI-2 certified, DIN rail mounting

Remote ceiling:

Art. Nr. 86458629-DE: DALI RM16 DE, 2000VA/16A, zero cross switching, integrated current limiter, 1 normal open, remote ceiling

Art. Nr. 86456203-DE: DALI-2 RM16 DE, 2000VA/16A, zero cross switching, integrated current limiter, 1 normal open, DALI-2 certified, remote ceiling

Art. Nr. 86458629-DE-WE: DALI RM16 DE WE, 2000VA/16A, zero cross switching, 1 changeover, remote ceiling

Art. Nr. 86458629-CEL: DALI RM16, 2000VA/16A, 1 normal open, fast commissioning (plug – fast commissioning)

Installation box:

Art. Nr. 86458629: DALI RM16, 1000VA/8A, zero cross switching, 1 changeover, back box

Art. Nr. 86456203: DALI-2 RM16, 1000VA/8A, zero cross switching, 1 changeover, DALI-2 certified, back box

Art. Nr. 86458675: DALI RM8, 1000VA/8A, zero cross switching, 1 normal open, back box

Art. Nr. 86456944: DALI-2 RM8, 1000VA/8A, zero cross switching, 1 normal open, DALI-2 certified, back box

Additional Information and Equipment

DALI-Cockpit – free configuration tool from Lunatone for DALI systems

<https://www.lunatone.com/en/product/dali-cockpit/>

Lunatone DALI products

<https://www.lunatone.com/en>

Lunatone datasheets and manuals

<https://www.lunatone.com/en/downloads-a-z/>

Contact

Technical Support: support@lunatone.com

Requests: sales@lunatone.com

www.lunatone.com



Art. Nr.: 86458675-_
and Art. Nr.: 86458629-_

Art. Nr.: 86456944-_
and Art. Nr.: 86456203-_

86458675, 86458675-HS,
86458629, 86458629-HS,
86458629-HS-WE



Disclaimer

Subject to change. Information provided without guarantee.
The datasheet refers to the current delivery.

The compatibility with other devices must be tested in advance
to the installation.

DALI RM

Datenblatt Relais Module

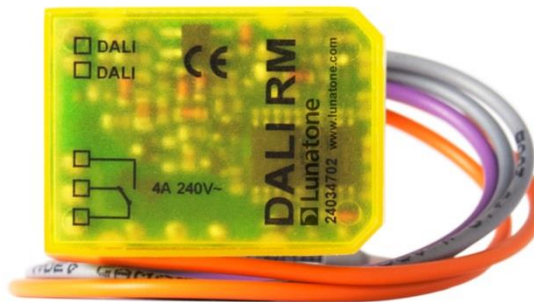

Modul zum Steuern eines
Relaiskontakts über den DALI-Bus

PHASED OUT
Art. Nr. 24034702

Änderungen vorbehalten, Angaben ohne Gewähr

DALI RM Relais Module

Überblick

- Kompaktes Relaismodul zum Ansteuern eines Standardschützes oder Last über DALI
- Einfaches Einbinden von Lasten ohne DALI-Eingang in einen DALI-Kreis, die Lasten können über DALI-Befehle ein- und ausgeschaltet werden
- Es können Ein- und Ausschaltpunkt konfiguriert werden, dafür werden die Parameter MIN LEVEL, MAX LEVEL, FADE RATE und FADE TIME verwendet
- Für die Konfiguration steht mit dem DALI-Cockpit ein kostenloses DALI-Konfigurationstool der Firma Lunatone zum Download zur Verfügung
- Die Versorgung des DALI RM erfolgt über den DALI-Bus
- Lasten dürfen nur dann an direkt an das DALI RM angeschlossen werden, wenn der Einschaltstrom der Last unter 6A liegt. Ansonsten ist ein Schütz zwischenzuschalten. Alternativ empfehlen wir für hohe Einschaltströme die Verwendung der Module DALI RM8 (bis 80A Einschaltstrom) oder DALI RM16 (bis 160A Einschaltstrom).
- An das DALI RM darf maximal die Last einer Schützspule angeschlossen werden.
- Bei der Auswahl des richtigen Schützes ist ebenfalls auf den Einschaltstrom des Schützes zu achten, dieser darf 6A nicht überschreiten
- DC-Schütz-Spulen sind mit Freilaufdioden auszustatten

Spezifikation, Kenndaten

Typ	DALI RM
Artikelnummer	24034702
Versorgung	aus DALI- Bus
typ. Stromaufnahme am DALI-Bus	10 mA
Eingänge	DALI
DALI Adresse	1
Ausgang Schaltspannung	250Vac/35Vdc
Ausgang Schaltstrom	4A
Max. Einschaltstrom der Last	6A
Kontaktart	1 Wechsler
mechanische Lebensdauer Schaltspiele	1x10 ⁷
elektrische Lebensdauer Schaltspiele (4A/250VAC, resistiv)	6x10 ⁴
Temperatur	-20°C ... +60°C
Schutzklasse	IP20
Querschnitt Anschlussdrähte	0.75 mm ²
Länge Anschlussdrähte	250 mm

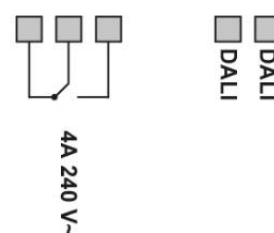

Anschlussplan

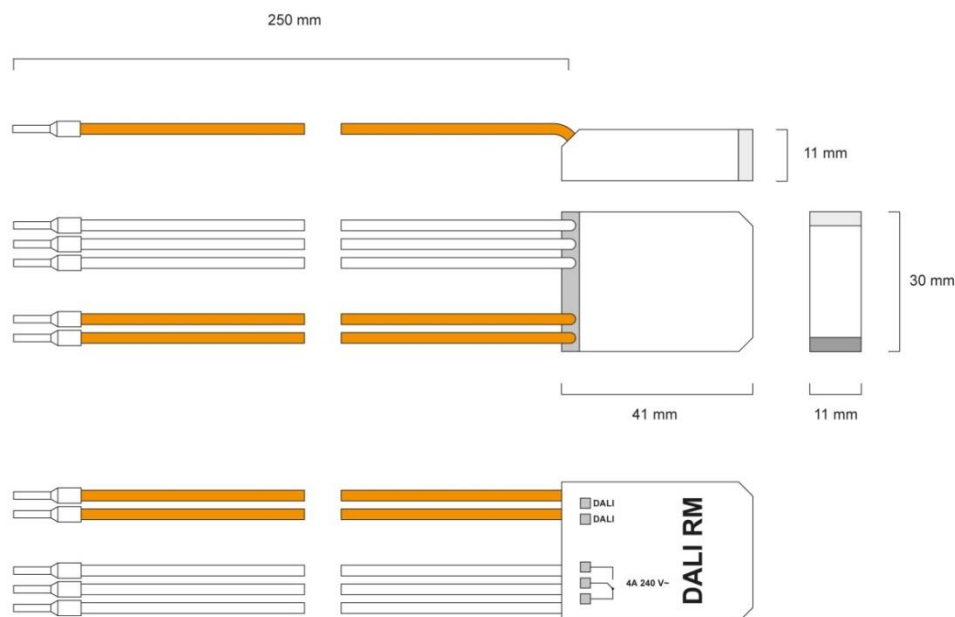

Geometrie

Anschluss

Das Relaismodul wird direkt am DALI-Bus angeschlossen und benötigt keine Versorgung, diese erfolgt direkt über den Bus. Im Unterschied zu einem Standard-EVG muss mit einer höheren Stromaufnahme von typisch 10mA ohne Busverkehr gerechnet werden. Im DALI-Kreis ist ein DALI Power Supply (DALI PS) zur Versorgung aller DALI-Module vorzusehen. Der Anschluss an die DALI-Klemmen kann ohne Beachtung der Polung erfolgen und ist gegen Überspannungen (Netzspannung) immun.

Der Relaisausgang verfügt über eine AC-Schaltleistung von 1000VA. Ein Schaltstrom von 4A ist garantiert. Beim direkten Schalten von Lasten oder auch von Schützen ist darauf zu achten, dass der Einschaltstrom 6A nicht überschreitet. Um Überspannungen vorzubeugen sind beim Ansteuern von DC-Schützspulen entsprechende Schutzmaßnahmen zu treffen (Freilaufdiode für Schützspule).

Für höhere Lasten oder Lasten mit hohen Einschaltströmen empfiehlt sich die Verwendung der Module DALI RM8 (Lunatone Art.Nr. 86458675) oder DALI RM16 (Lunatone Art.Nr. 86458629). Beide verfügen über ein bistabiles Relais für Schaltströme bis 8A bzw. bis 16A und Einschaltströme bis 80A bzw. bis 160A.

Für die einwandfreie Funktion des Relaismoduls muss gewährleistet sein, dass die Versorgungsspannung am Modul durch lange Leitungen und damit verbundenen Spannungsabfällen nicht unter 13V sinkt.

DALI Funktionen und Befehlssatz

Das DALI RM bietet die Möglichkeit Lasten ohne DALI-Eingang an den DALI-Bus anzubinden und anschließend ein- und auszuschalten.

Das DALI RM verhält sich dabei soweit wie möglich wie eine Standard DALI Gerät. Es ist als Schnittstelle zu beliebigen Lasten an die Norm für DALI Control Gears (IEC 62386-102)

und Device Type 0 Geräte (IEC62386-201) angelehnt.

Bis auf wenige Ausnahmen wird die komplette DALI-Befehlspalette unterstützt, bei einigen Befehlen und Funktionalitäten gibt es allerdings Einschränkungen bzw. Änderungen:

- Relais schaltet bei Überschreiten des MAX-LEVELs ein
- Relais schaltet bei Unterschreitung des MIN-LEVELs aus
- SYSTEM FAILURE LEVEL – bei fehlender Busverbindung (Versorgung) fällt das Relais ab
- Eine Fehlerrückmeldung ist nicht möglich, ein QUERY LAMP FAILURE liefert immer NO zurück, QUERY STATUS bit 0&1 nicht implementiert
- Beim Speichern eines Szenenwerts wird neben dem „ACTUAL LEVEL“ der Relaiszustand gespeichert, welcher ausschlaggebend für den EIN/AUS-Zustand des Szenenwertes ist. Es ist beim Speichern einer Szene unbedingt darauf zu achten, dass das Relais den gewünschten Zustand hat.

Funktionsweise

Das DALI RM verhält sich bis auf wenige Abweichungen wie ein Standard DALI Gerät. Als Schaltschwelle für das Relais werden der MIN- und der MAX-Pegel verwendet.

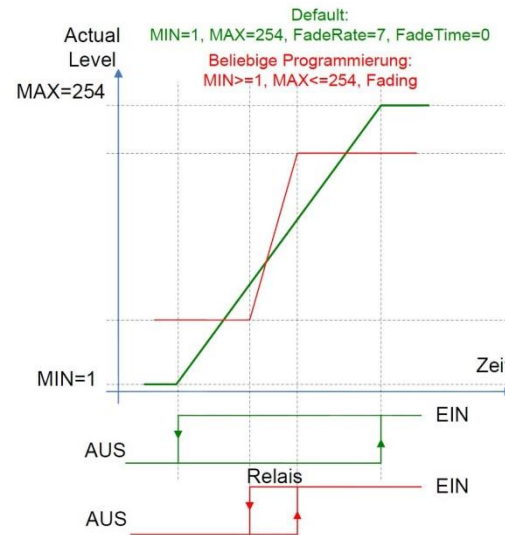

Einschalten erfolgt wenn der ACTUAL LEVEL den MAX-Wert überschreitet, ausschalten erfolgt hingegen bei Unterschreiten des MIN-Werts. Auf den Actual Level werden die Fading-Parameter wie im DALI-Standard vorgesehen angewendet. Demnach ist mit diesen Parametern eine Hysterese für das Schaltverhalten programmierbar.

Adressierung und Konfiguration

Über ein DALI-Steuergerät oder ein Konfigurationstool kann das DALI RM adressiert (nur Random Addressing) und die Parameter konfiguriert werden.

Lunatone bietet dafür eine kostenlose Software zum Download an. Mithilfe des DALI-Cockpits (Software) und dem DALI-USB (Schnittstellenmodul zwischen DALI-Kreis und PC via USB) kann das DALI-RM adressiert und konfiguriert werden.

Weiterführende Informationen und Zubehör

DALI-Cockpit – kostenlose Konfigurationssoftware für DALI-Systeme

<http://lunatone.at/de/dali-systeme/software/>

DALI-Manual German http://www.dali-ag.org/c/manual_germanlanguag.pdf

DALI USB – Schnittstelle von einem PC zu einem DALI-Kreis, damit kann mit dem DALI-Cockpit auf die einzelnen Komponenten im DALI-Kreis zugegriffen werden.

http://lunatone.at/de/downloads/Lunatone_Art24138923_DALI_USB_Datasheet_GER.pdf

DALI PS – Power Supply, Stromversorgungseinheit für einen DALI-Kreis.

http://lunatone.at/de/downloads/Lunatone_Art24033444_DALI_PS_Datasheet_GER.pdf

Kontakt:

Technische Fragen: support@lunatone.com

Anfragen: sales@lunatone.com

www.lunatone.com

Disclaimer

Änderungen vorbehalten. Alle Angaben ohne Gewähr. Das Datenblatt bezieht sich auf den aktuellen Auslieferungszustand

Die Funktion in Installationen mit anderen Geräten muss vorab auf Kompatibilität geprüft werden.