



DALI-2 MC4L

Datasheet

Multi Control Device

DALI control module with four
with four programmable switching
inputs for mains voltage

Art. Nr. 86458507-4L-__-__

GTIN 9010342012754



Art. Nr. 86458507-4L-2-**app**

factory default setting: **App-Controller activated**

Art. Nr. 86458507-4L-2-**int**

factory default setting: **Instances activated**

Art. Nr. 86458507-4L-**NFC**

Version with NFC functionality
factory default setting: **App-Controller activated**

Art. Nr. 86458507-4L-**HS-2-app**

DIN rail version
factory default setting: **App-Controller activated**

Art. Nr. 86458507-4L-**HS-2-int**

DIN rail version
factory default setting: **Instances activated**



DALI-2 MC4L Control Device

Overview

- DALI-2 control module with 4 switching inputs for mains voltage
- galvanic isolation between switching input and DALI-line
- Multi-master capable: Several modules can be installed within a DALI circuit.
- Different DALI commands, destination addresses and switching modes can be assigned to each input
- Integrated DALI-2 application controller
- Four DALI-2 pushbutton instances are available for an easy integration
- In addition to the standard DALI commands, the application controller also supports DALI DT8 TC and RGB (W) control
- short button press, long button press (with repetition for dimming) and «toggle» are supported
- Suitable for push-buttons, as well as switches
- New: Alternative button function: A second function can be assigned to each input. Activated / deactivated via a scene command or switch at input 4. Thus, Offering an easy solution to the partition wall problem.
- With the application controller Sequences, macros and other functions can be realised.
- Easy configuration via Lunatone DALI USB interface and DALI-Cockpit Software Tool.
- New: NFC variant for simple, contactless configuration with the Lunatone NFC smartphone app
- Easy installation: the device can be installed in a flush-mounted installation box and is supplied via the DALI bus
- Version for DIN rail mounting is also available
- Light indication of active inputs on DIN rail version
- DALI-2 control unit according to IEC62386-103



Specification, Characteristics

Variants:

Type	DALI-2 MC4L			DALI-2 MC4L HS	
article number	86458507-4L			86458507-4L-HS	
mounting	back box installation			DIN rail	
variants	standard	integration	NFC	standard	integration
Art. Nr. addition	-2-app	-2-int	-NFC	-2-app	-2-int
factory default setting	app-Controller activated	instances activated	app-controller activated	app-controller activated	instances activated

Type	DALI-2 MC4L	DALI-2 MC4L-HS
article number	86458507-4L-__-__	
GTIN	9010342012754	

DALI interface, power supply: DA, DA

output type	DALI, DALI-2, Multi Master, power supply
terminal markings	DA, DA
voltage range	9,5V ... 22,5Vdc according to IEC62386
typical current consumption DALI (16,5V)	1.7 mA
max. current consumption DALI (22,5V)	2,6 mA
DALI addresses	none
DALI-2 addresses	1

Input: L1, L2, L3, L4, N

Input type	switching input
number of inputs	4
marking input terminals	L1, L2, L3, L4, N
input voltage range	230Vac
tolerance of input voltage	+20%/-25%
frequency of a.c. voltage	50Hz ... 60Hz
control impulse length min.	40ms
control impulse length for long press	>500ms
input resistance	660kΩ
wire length max.	10m (up to 50m in an interference-free environment i.e. no parallel power lines)
max. voltage between inputs	230Vac

insulation data:

impulse voltage category	II
pollution degree	2
rated insulation voltage	250V
rated impulse withstanding voltage	4kV
insulation DALI / mains	reinforced isolation
insulation test voltage DALI / mains	3000Vac

environmental conditions:

storing and transportation temperature	-20°C ... +75°C
operational ambient temperature	-20°C ... +75°C
rel. humidity, not condensing	15% ... 90%

general data:

dimensions (l x w x h)	59mm x 33mm x 15mm	98mm x 17,5mm x 56mm
mounting	back box installation installation in protection class II devices	DIN rail, built-in
rated maximum temperature t_c	75°C	
expected life time	50.000h	
protection class	SKII (when used/installed as intended)	
protection degree housing	IP40	
protection degree terminals	IP20	

terminals:

connection type	spring terminal connectors	screw terminal
wire size: solid core	0,5 ... 1,5 mm ² (AWG20 ... AWG16)	0,5 ... 2,5 mm ² (AWG20 ... AWG14)
wire size: fine wired	0,5 ... 1,5 mm ² (AWG20 ...AWG16)	0,5 ... 2,5 mm ² (AWG20 ...AWG14)
wire size: using wire end ferrule	0,25 ... 1 mm ²	0,25 ... 1,5 mm ²
stripping length	8,5 ... 9,5 mm / 0,33 ... 0,37 inch	7 mm / 0,27 inch
tightening/ release of wire	push mechanism	screw
tightening torque	-	0,5Nm

standards :

DALI	IEC62386-101:2014 IEC62386-103:2014
EMV	EN 61547 EN 50015 / IEC CISPR15
safety	EN 61347-2-11 EN 61347-1
Markings	DALI-2, CE

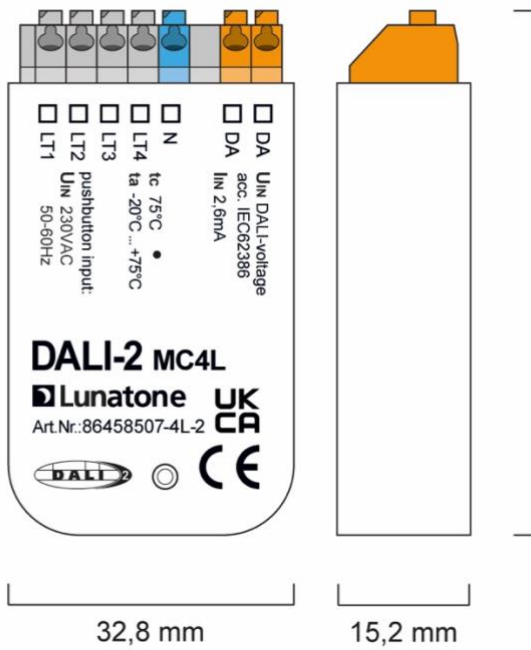

dimensions DALI-2 MC4L

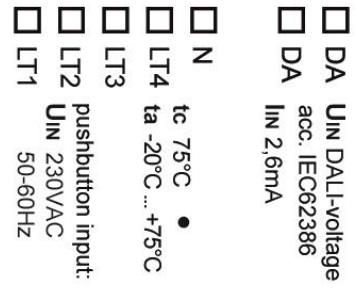

connectors DALI-2 MC4L

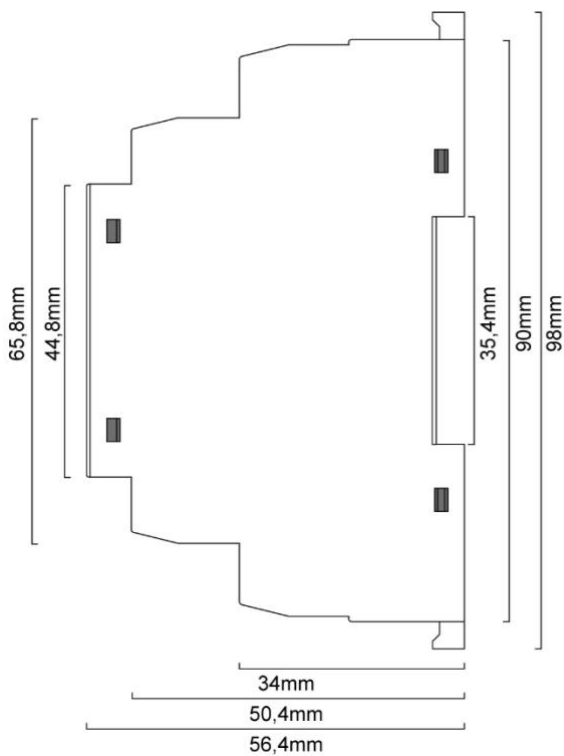

dimensions DALI-2 MC4L-HS

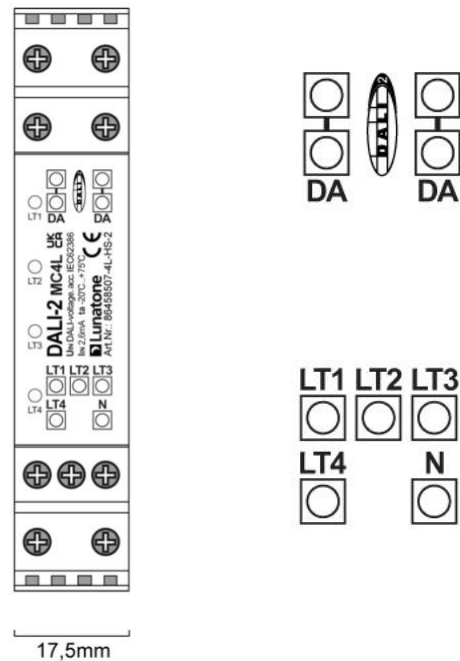

connectors DALI-2 MC4L-HS

Factory Default Settings

A basic configuration is already implemented on delivery (factory default setting). If necessary, this can be changed and adapted.

Version Application Controller art.nr.: 86458507-4L-2-app, 86458507-4L-NFC, 86458507-4L-HS-2-app:

	input LT1	input LT2	input LT3	input LT4
application controller	active			
instances – event messages	inactive	inactive	inactive	inactive
effective range	Broadcast	Broadcast	Broadcast	Broadcast
button function	BF6: toggle CmdX/CmdY long press: toggle UP/DOWN	BF10: short press: CmdX, long press: repeat CmdY	BF10: short press: CmdX, long press: repeat CmdY	BF13: toggle CmdX/CmdY long press: toggle COLDER/WARMER
command X (CmdX)	RECALL MAX	RECALL MAX	OFF	RECALL MAX
command Y (CmdY)	OFF	UP	DOWN	OFF
command on power up	none	none	none	none

Version Integration art.nr.: 86458507-4L-2-int and 86458507-4L-HS-2-int:

	input LT1	input LT2	input LT3	input LT4
application controller	inactive			
instances – event messages	active	active	active	active
effective range	--	--	--	--
button function	--	--	--	--
command X (CmdX)	--	--	--	--
command Y (CmdY)	--	--	--	--
command on power up	--	--	--	--

Typical application

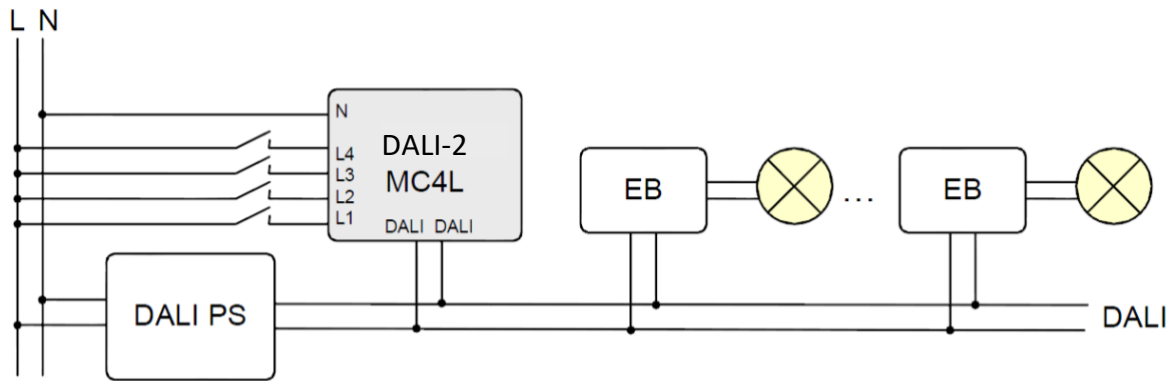

Fig. 1 Typical Application, wiring diagram

Installation

- The DALI-2 MC4L can be installed in a flush-mounted installation box
- The DALI-2 MC4L-HS is suitable for DIN rail mounting, protection against electric shock has to be ensured by an appropriate enclosure. The 4 LEDs indicate which inputs L1-L4 are currently active.
- The device is directly connected and supplied by the DALI bus. A DALI bus power supply (e.g. DALI PS) is required.
- The connection to the DALI terminals can be made regardless of polarity. The bus input is protected against overvoltage (mains voltage).
- The wiring should be carried out as a permanent installation in a dry and clean environment.
- Installation may only be carried out in a voltage-free state of the system and by qualified specialists.
- National regulations for setting up electrical systems must be followed.
- The DALI wiring can be realised with standard low-voltage installation material. No special cables are required.
- Only 1 wire may be connected to each terminal. When using double wire end ferrules, the connection capacity of the terminal must be considered.
- Switching inputs are intended for use with line voltage, they are galvanically separated from the DALI-line



Attention: The DALI-signal is not classified as SELV circuit (Safety Extra Low Voltage). Therefore, the installation regulations for low voltage apply.



The voltage drop on the DALI line must not exceed 2V at maximum length (300m) and maximum bus load (250mA).

Addressing and Configuration

- After installation, the device can already be used with the default factory settings. A description of the factory default settings can be found on page 14.
- DALI-2 MC4L: Addressing and changes to the factory settings, such as setting the effective range and functions, are possible with the Software tool DALI Cockpit (Windows PC).
- DALI-2 MC4L-NFC: Addressing and changes to the factory settings, such as setting the effective range and functions, are possible with the Software tool DALI Cockpit (Windows PC) and the Lunatone DALI NFC smartphone app.
- When using the the [DALI Cockpit Software](#), the PC must be connected to the DALI bus via a suitable interface module ([DALI-2 USB](#); [DALI USB](#), [DALI-2 WLAN](#), [DALI-2 Display](#), [DALI-2 IoT](#), [DALI 4Net](#), [DALI SCI RS232](#)). The DALI-2 MC4L is automatically recognised by the DALI Cockpit during the addressing process and listed in the device overview. Effective range and desired functions can then be assigned to each input.
- The addressing is done according to the DALI-2 specification and the device receives a corresponding address.

- For localisation a buzzer is integrated in each DALI-2 MC4L device. Alternatively, the allocation can also be done via the serial number of the device.
- Physical selection: At the end of the addressing process, by double-clicking the physical button, the DALI Cockpit identifies and adds the input connections (LT1 to LT4 on the device) to the device list.

Operation and function

The DALI-2 MC4L is a universal module to control DALI-compatible lights. The function of each push button input can be set individually.

As with other Lunatone control devices, the settings can be made with the DALI Cockpit Software tool.

It is necessary to distinguish between application controller and DALI-2 instances.

The application controller gives direct DALI control commands that are immediately executed by the DALI drivers. Configuration of the application is described in the section “Application Controller: Configuration of inputsError! Reference source not found.” on page 9

The DALI-2 instances generate event messages that are interpreted and processed by higher-level control units (WAGO, Beckhoff, LUNATONE DALI-2 KNX gateway). (General information on the DALI-2 instance mode: https://www.lunatone.com/wp-content/uploads/2021/10/DALI-2_Instance-Guide_EN_M0024.pdf)

Configuration of the DALI-2 MC2L instances is described in section: “DALI-2 instances” on page 14.

The Application controller and instances can be active at the same time.

Additional Information: A deactivated Application Controller is indicated in the DALI Cockpit device tree with: **A**.

A device with active instances is indicated with: **i**

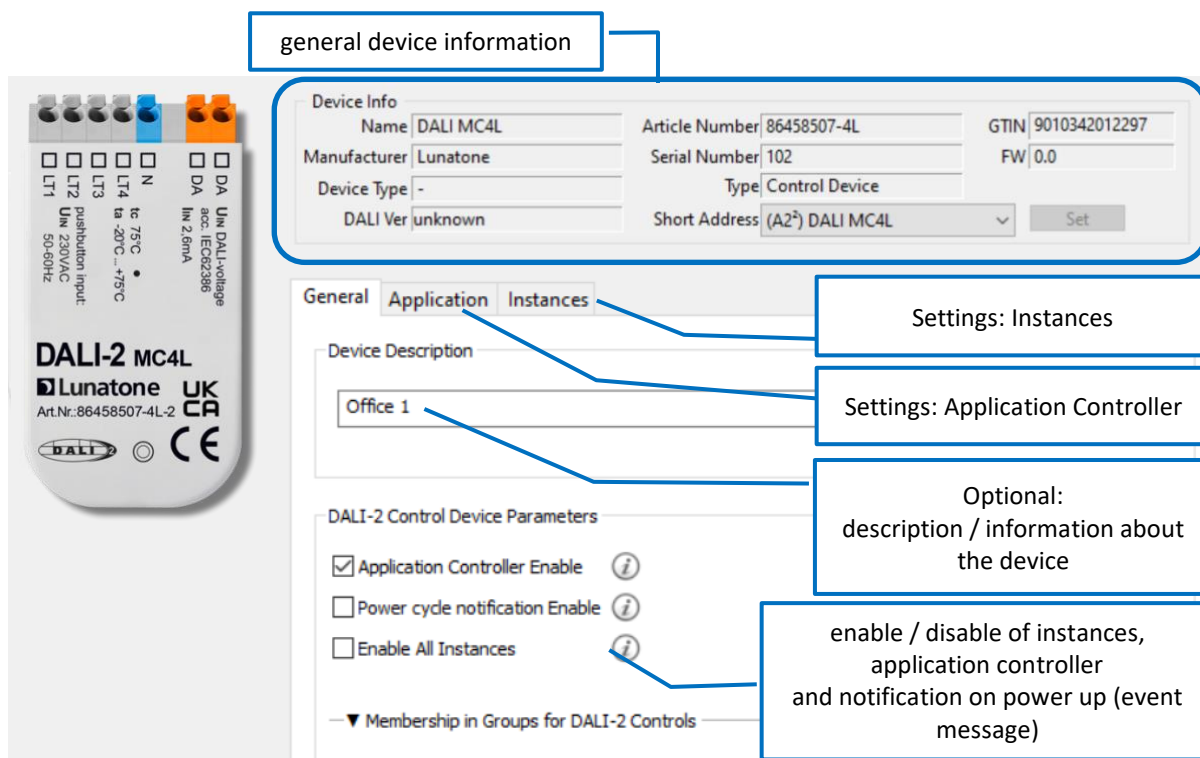

Fig.2: General Settings

Application Controller: Configuration of inputs (LT1 – LT4)

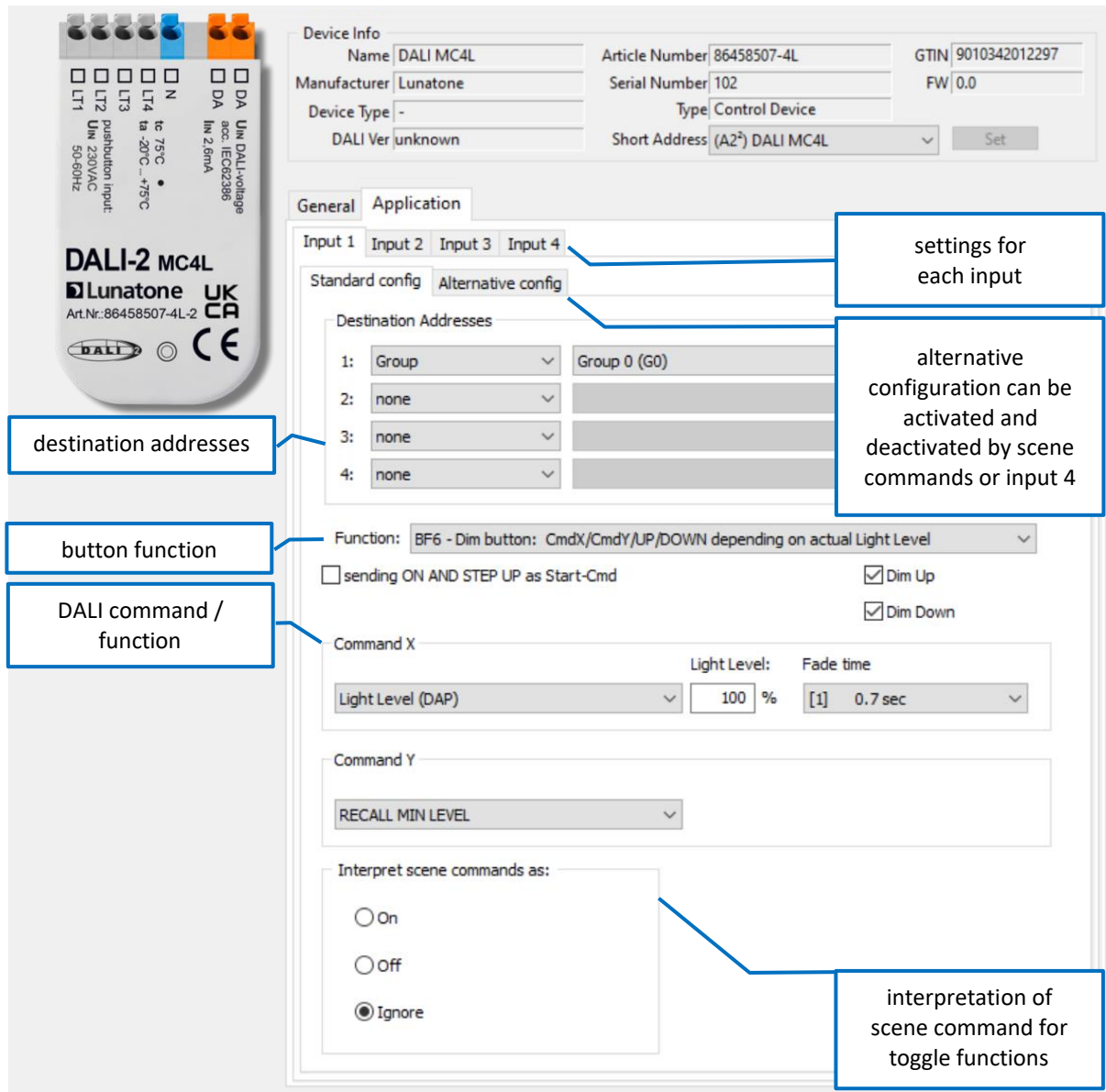

Fig. 3: Application: Application Controller

Destination address / effective range

Here you can set which devices are affected by the button function. Possible destination addresses:

- Broadcast (an alle)
- DALI group (0 - 15)
- DALI single address (0 - 63)

Up to 4 different target addresses can be defined for each button input. When the button is pressed the target addresses 1 to 4 will be processed sequentially (see Fig. 4)

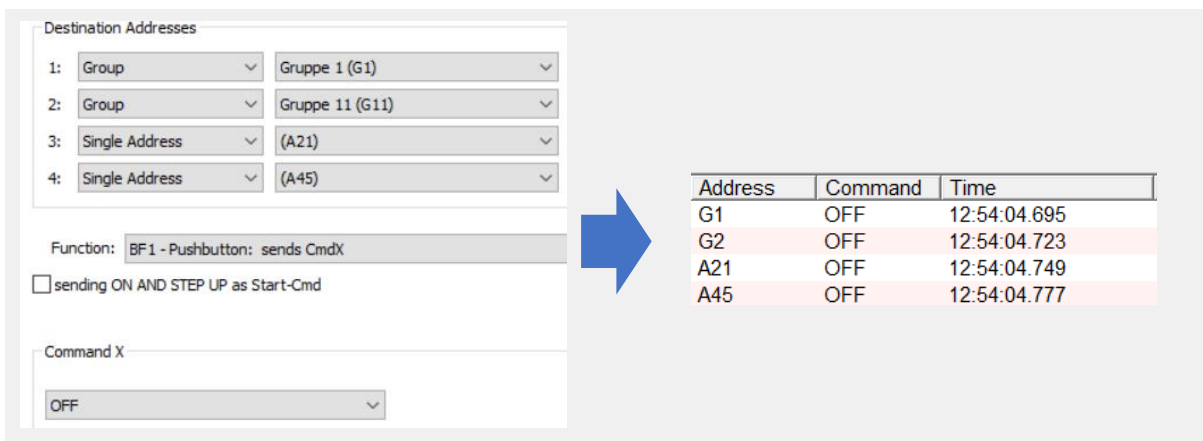

Fig.4 Example: Addressing Inputs 1-4 – sequentially processed

Button Function (BF)

Various "Button Functions" (BF) can be assigned to the individual buttons. The "Button Function" defines the behaviour of a button. A short or long press of the button can trigger different DALI commands. A toggle

function (switching between on and off) is also possible. Key presses (short / long) are queried according to the following timing diagram and translated into internal signals (**key events**):

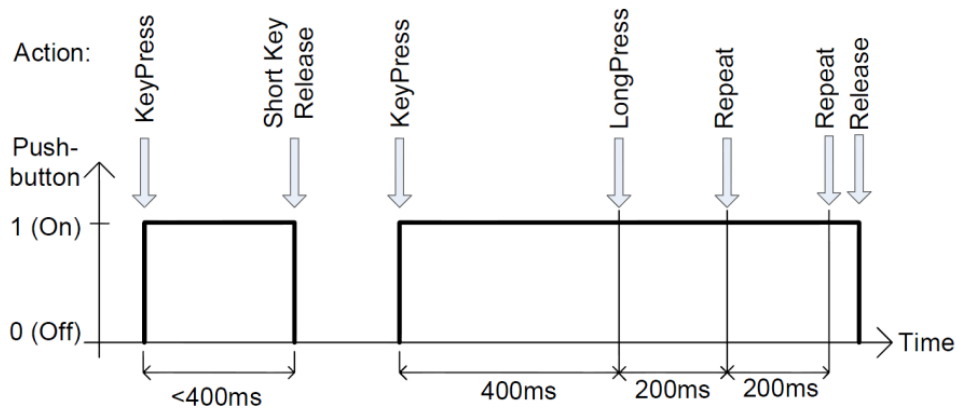

Fig.5 Key Events

The following table (tab. 1) shows how the selected "Button Function" (lines 0 to 13) sends the commands **CmdX** and **CmdY** in connection with the "Key Events" (see Fig. 5). CmdX and CmdY refer to DALI commands.

Note: The DALI commands are transmitted to all assigned target addresses.

button function number	event: press	event: short press (release)	event: long press	event: extra-long press	event: repeat	function	typical application
0	-	-	-	-	-	-	-
1	CmdX	-	-	-	-	sends CmdX on key press	master off
2	CmdX	-	CmdY	-	-	sends CmdX on key press sends CmdY on long key press	switch to 2 different levels
3	-	CmdX	-	CmdY	-	sends CmdX on key press sends CmdY on extra-long key press	store level as scene
4	CmdX / CmdY toggle	-	-	-	-	sends alternating CmdX and CmdY on key press	toggle push button
5	CmdX / CmdY toggle	-	-	-	-	sends CmdX or CmdY on key press depending on bus status	changeover button
6	-	CmdX / CmdY toggle	UP / DOWN	-	UP / DOWN	sends CmdX or CmdY on short key press depending on bus status sends alternating UP or DOWN on long press and repeat	push and dim
7	CmdX CmdY on any release	-	-	-	-	sends CmdX on key press sends CmdY on key release (after any duration)	switch
8	CmdX / CmdY toggle CmdY / CmdX toggle on any release	-	-	-	-	sends CmdX or CmdY on key press depending on bus status sends CmdY or CmdX on key release (after any duration) depending on bus status	changeover switch
9	CmdX CmdY on delay	-	-	-	-	sends CmdX on key press sends CmdY after a programmable delay	staircase control
10	-	CmdX	CmdY	-	CmdY	sends CmdX on short key press sends CmdY on long key press sends CmdY on repeat	push and dim
11	CmdX	-	-	-	CmdY	sends CmdX on key press sends CmdY on repeat	push and dim
13	-	CmdX / CmdY toggle	-	-	WARMER / COOLER	sends CmdX or CmdY on short key press depending on bus status sends alternating WARMER or COOLER on repeat	tunable white dim

Tab. 1

Commands

The actual action (which function is triggered when pressing a button) is determined by the button function and command assigned to the button.

In most cases, an X command (CmdX) and also a Y command (CmdY) can be selected.

The following options are available, see table 2.

Depending on the selected command, additional input fields might appear for further settings, see figure 6.

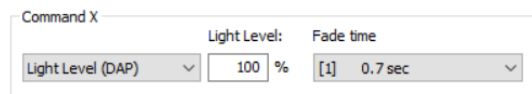

Fig. 6 Example for CmdX: DAP additional inputs: Light Level and Fade time

Predefined macros

Macros are predefined/ user defined command sequences that can be triggered by a single button press.

The following macros are available, see table 3.

Command number	Command name	action / function
no Nr.	DIRECT ARC POWER	direct arc power Level in %
0	OFF	off
1	UP	dim up (using fade rate)
2	DOWN	dim down (using fade rate)
3	STEP UP	increases light level by one increment
4	STEP DOWN	decreases light level by one increment
5	RECALL MAX	recalls MAX value
6	RECALL MIN	recalls MIN value
7	STEP DOWN AND OFF	decreases light level by one increment, if value at MIN switch off
8	ON AND STEP UP	increases light level by one increment, if OFF switch on
10	GOTO LAST ACTIVE LEVEL (DALI 2)	DALI-2-Cmd for switching on to the last active level (Memory-Function)
16-31	GO TO SCENE	go to scene 0-15

Tab. 2

Nr	Makro	Funktion
M1	Go Home	Light dims down to DAP 0 with predefined fade time, then fade time is set back to a programmable value
M2	Sequential Scenes	A list of the scenes can be defined; the scene is switched with each button press.
M3	Dynamic Scenes	A dynamic sequence of up to 16 scenes can be defined, including custom fade times and delays.
M4	Save actual light level as scene	When triggered the current level is saved in a scene (options: light level, RGB colour value, WAF colour value or colour temperature).
M5	User Defined Cmd-List	A user-defined macro script with up to 19 commands is executed.
M6	TC cooler	Activates the DT8 mode and sends the command "COOLER" 3 times.
M7	TC warmer	Activates the DT8 mode and sends the command "WARMER" 3 times.
M8	Send RGB +	Activates the DT8 mode and sends an ascending RGB color table value.
M9	Send RGB -	Activates the DT8 mode and sends a descending RGB color table value.
M10	Delayed Off	Sends a DAP level and after a delay the OFF command. DAP level and delay are user defined.

Tab. 3

Interpretation of scene commands when using toggle function

In order to correctly trigger the on and off commands with the toggle function, scene calls must be interpreted correctly. It is possible to set whether a scene should be interpreted as Off or On (Fig 8).

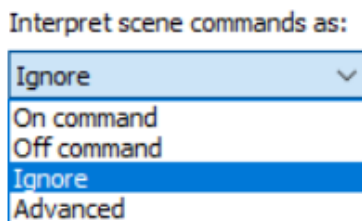

Fig. 8

Behaviour on power-up

The behaviour when the device starts can be defined for each input. The following settings are possible:

- No action: (the device starts and only sends commands when triggered by the input)
- Sending a scene or OFF command with or without a delay after start (maximum delay: 7 seconds)

Alternative configuration

An alternative/second configuration can be made for each button. All previously explained configuration options and settings are available. The alternative configuration can be recalled with button input 4 or a scene command.

Activate / deactivate the "Alternative Configuration":

- **"Disabled"**: the function is switched off, there is only the standard configuration
- **"Activation by Input 4"**: the standard and alternative configuration are switched with a button connected to input 4.
- **"Activation by Scene Commands"**: scenes can be selected which will activate / deactivate the alternative configuration

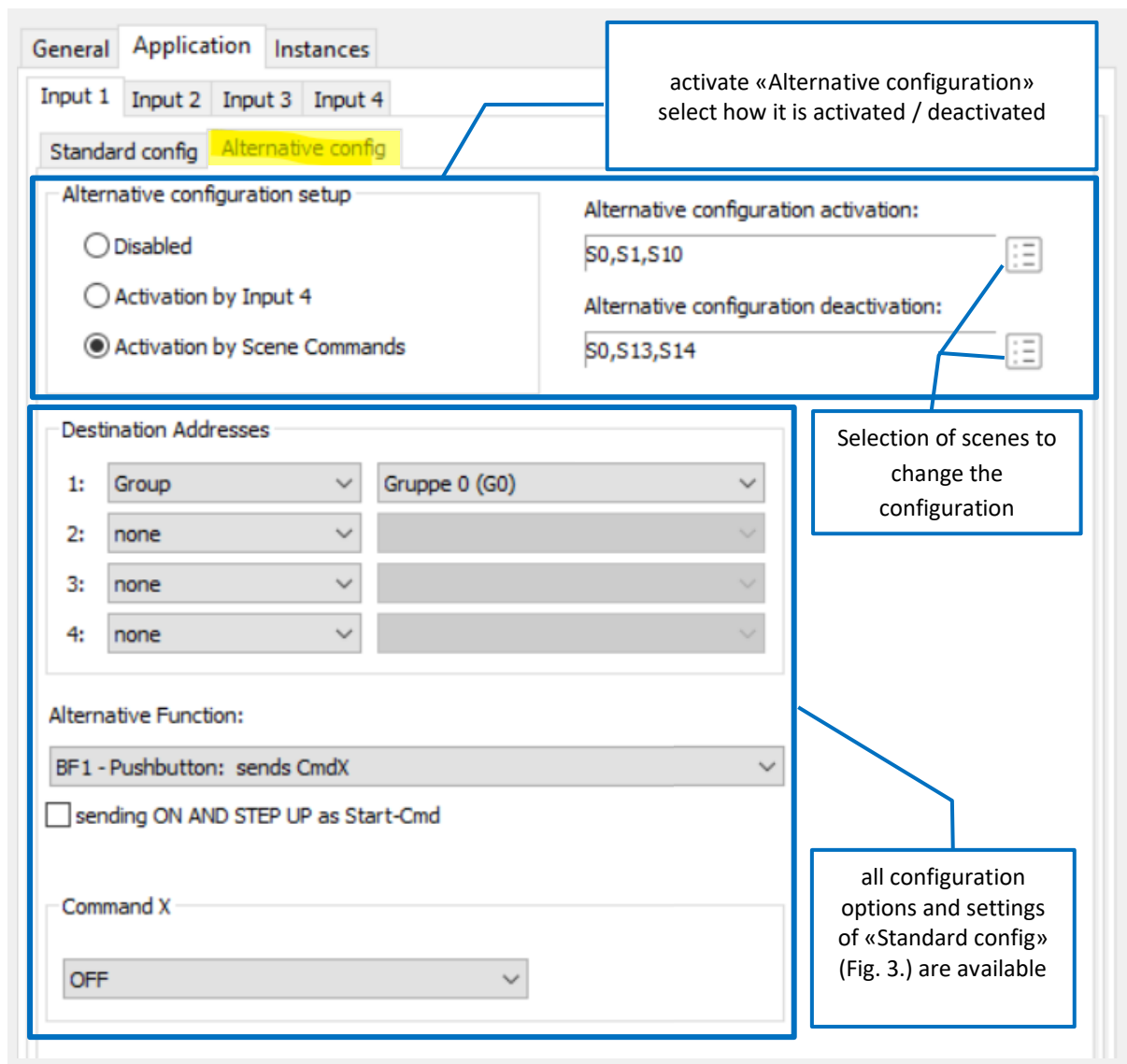

Fig. 7 Settings for the alternative configuration

DALI-2 instances

In this operating mode, no DALI control commands are sent on the bus, but DALI-2 event messages for DALI-2 compatible central control systems.

The DALI-2-MC4L supports 4 instances of type 1 (IEC62386-301, Input Devices - Push Button), which are assigned to the 4 button inputs as follows:

instance 0	input LT1
instance 1	input LT2
instance 2	input LT3
instance 3	input LT4

As defined in the standard, the following events are supported and sent on the DALI bus as INPUT NOTIFICATIONS, see table 4.

Further parameters of the instances 1-4 are: event filter, event timer settings (short timer, double timer, repeat timer, stuck timer), which can be configured via the DALI Cockpit Software, see figure 9.

General information on the DALI-2 instance mode and the instance types, event settings, event schemas etc. can be found in the instance guide:

https://www.lunatone.com/wp-content/uploads/2021/10/DALI-2_Instance-Guide_EN_M0024.pdf

Event name	Event Information	Description
Button released	00 0000 0000b	The button is released
Button pressed	00 0000 0001b	The button is pressed
Short press	00 0000 0010b	The button is pressed and released, without being pressed quickly again (in case of double press enabled), or the button is pressed and quickly released (in case of double press disabled)
Double press	00 0000 0101b	The button is pressed and released, quickly followed by another button press
Long press start	00 0000 1001b	The button is pressed without releasing it
Long press repeat	00 0000 1011b	Following a long press start condition the button is still pressed, the event occurs at regular intervals as long as the condition holds
Long press stop	00 0000 1100b	Following a long press start condition, the button is released
Button free	00 0000 1110b	The button has been stuck and is now released
Button stuck	00 0000 1111b	The button has been pressed for a very long time and is assumed stuck.

Tab.4

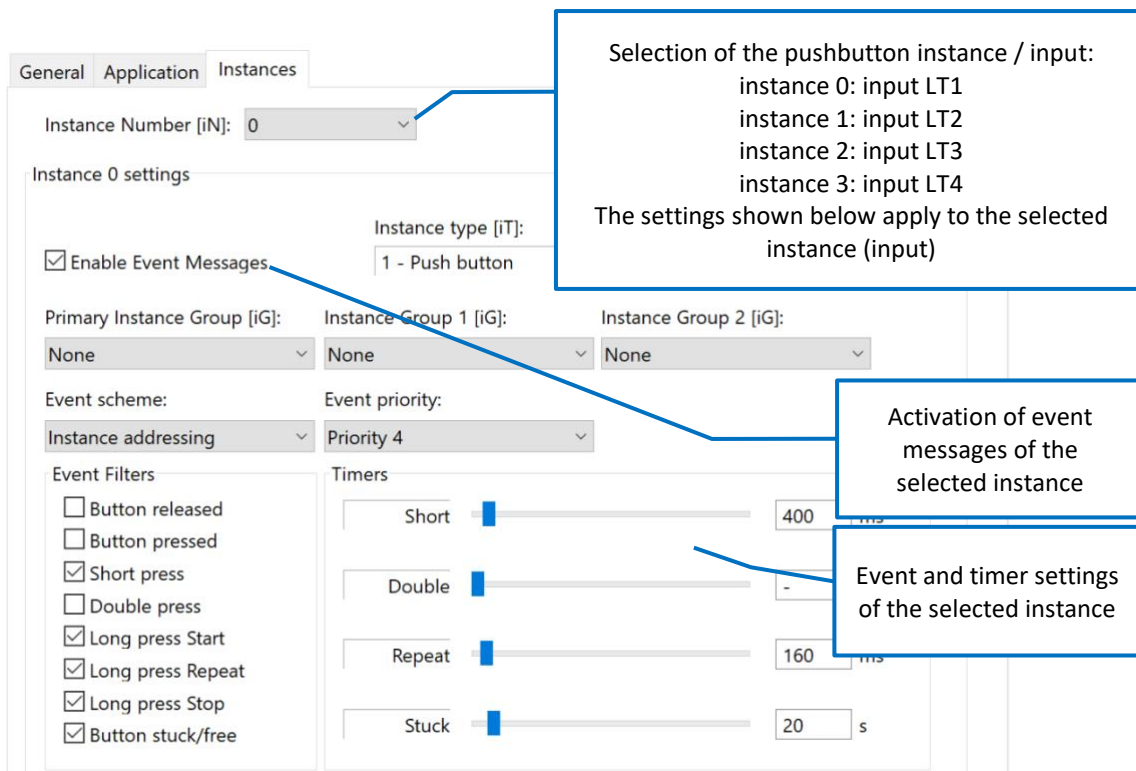

Fig. 9 Instance Settings

Application example – multiple switches and groups

Input LT1	group 1	ON/OFF dependent on current light status
Input LT2	group 2	ON/OFF dependent on current light status
Input LT3	group 3	ON for a certain time interval then OFF e.g. for cellar lights, ventilation, staircase lights ...
Input LT4	all	ON/OFF dependent on current light status

Cockpit Settings

<p>Input 1: Destination Address: Group 1 Button Function: 7 (Switch) CmdX (OnCommand): Light Level 100% CmdY (OffCommand): OFF</p>	<p>Input 2: Destination Address: Group 2 Button Function: 7 (Switch) CmdX (OnCommand): Light Level 100% CmdY (OffCommand): OFF</p>
<p>Input 3: Destination Address: Group 3 Button Function: 9 (Staircase) CmdX (OnCommand): Light Level 100% Delay: 10 minutes CmdY/OffCommand: OFF</p>	<p>Input 4: Destination Address: Broadcast Button Function: 7 (Switch) CmdX (OnCommand): Light Level 100% CmdY (OffCommand): OFF</p>

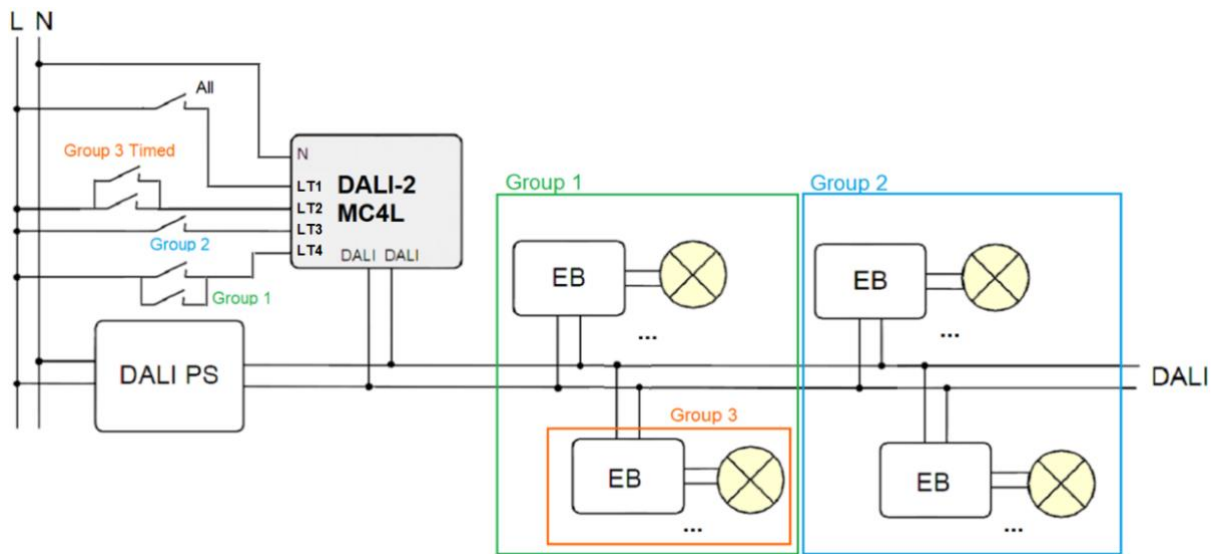

NFC-Version (Art.Nr.: 86458507-4L-NFC)

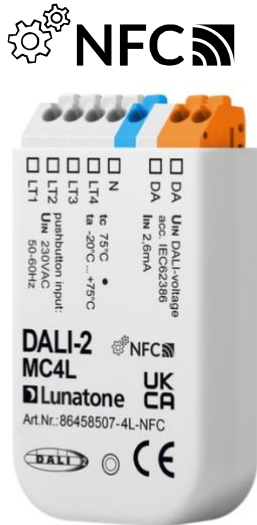

Fig. 10

In addition to the DALI Cockpit Software, the DALI-2 MC4L NFC includes a nearfield communication interface. This allows configuration over the NFC interface and a smartphone app.

- The DALI-2 MC4L does not have to be connected to a DALI power supply for configuration with NFC, it is supplied directly via NFC.
- The functions required to operate the application controller can be configured with the Lunatone DALI NFC App.
- Easy to use smartphone app for quick configuration in the field as well as preparation before installation.
- Fast transfer and copying of device settings

App Download

The Lunatone "DALI NFC" app is available for Android devices on the Play Store.



Connect

- Switch on the NFC function and start the "DALI NFC" app.
- This is followed by the request to pair an "NFC-enabled device".
- As soon as the DALI-2 MC4L NFC is within range (indicated by signal tone / vibration) the device is automatically read out and shown on the display.



Fig. 11 NFC App Start Screen



It is important that the NFC antennas of the two devices are as close as possible to each other. The position of the antenna is marked on the DALI-2-MC4L-NFC:



Fig. 12



For Information on the NFC interface of your smartphone please check the instructions of the device manufacturer.

Lunatone DALI NFC App

The configuration options are the same as in the DALI Cockpit, see section "Operation and function" page 6 for further information.

The screenshot shows the configuration interface for a DALI-2 MC4L device. The top section displays the device's physical image and key information: **DALI-2 MC4L**, Firmware V1.0, Article No. 86459532-NFC, and Serial No. 81604388773. The **Addressing** section shows the current address is 3, with an option to increment by 4, and Control Device Groups set to none. The **Device Settings** section is for **Input 1** and includes a table for Destination Address, a dropdown for Function (set to BF1: PUSH BUTTON), and a **SAVE TO DEVICE** button at the bottom.

Annotations:

- device information:** Points to the top section containing the device image and identification details.
- device address:** Points to the 'Address' field in the Addressing section.
- Device settings of the 4 push button inputs:** Points to the 'Device Settings' section.
- selection which push button input (L1 - L4) should be configured:** Points to the 'Input 1' header and the '2', '3', '4' tabs.
- Destination addresses:** Points to the 'Destination Address' list with options 1: group, 2: none, 3: none, 4: none.
- selection of button function behaviour:** Points to the 'Function' dropdown menu.
- DALI command / function:** Points to the 'BF1: PUSH BUTTON - sends CmdX' option.
- "Save to device": parameters are saved on the device:** Points to the 'SAVE TO DEVICE' button at the bottom of the screen.

 Macros and instances cannot be set via NFC.

Fig. 13

Purchase Information

Art. Nr. 86458507-4L-2-app**DALI-2 MC4L:**

for back box installation

factory default setting: **App-Controller activated****Art. Nr. 86458507-4L-2-int****DALI-2 MC4L integration:**

for back box installation

factory default setting: **instances activated****Art. Nr. 86458507-4L-NFC****DALI-2 MC4L NFC:**

for back box installation

factory default setting: **App-Controller activated****Art. Nr. 86458507-4L-HS-2-app****DALI-2 MC4L:**

for DIN rail installation

factory default setting: **App-Controller activated****Art. Nr. 86458507-4L-HS-2-int****DALI-2 MC4L integration:**

for DIN rail installation

factory default setting: **instances activated**

Additional Information and Equipment

DALI Cockpit - free configuration software for DALI systems

<https://www.lunatone.com/en/product/dali-cockpit/>

Lunatone DALI products

<https://www.lunatone.com/en>

Lunatone Datasheets and Manuals

<https://www.lunatone.com/en/download-s-a-z/>

Lunatone DALI NFC App

<https://play.google.com/store/apps/details?id=com.lunatone.dalinf&hl=de>

Contact

Technical Support: support@lunatone.comRequests: sales@lunatone.comwww.lunatone.com

Disclaimer

Subject to change. Information provided without guarantee. The datasheet refers to the current delivery.

The function in installations with other devices must be tested for compatibility in advance.